

Pressure Sensor Series *PSE530*

How to Order

PSE53 **0** — **M5** —

Pressure sensing range

0	High pressure [0 to 1 MPa]
1	Vacuum [0 to -101 kPa]
2	Low pressure [0 to 101 kPa]
3	Compound pressure [-101 to 101 kPa]

Port size

M5	M5 x 0.8
-----------	----------



Option

When only optional parts are required, order using the part numbers listed below.

Description	Part no.	Note
Connector	ZS-26-E	4 pcs. per set
Sensor cable	ZS-26-F	Cable length: 3 m
Connector + Sensor cable	ZS-26-G	Cable length: 3 m The connector is not connected to the cable at the time of shipment.

Option

Option	Description
Nil	Without cable
L	Sensor cable (3 m)
CL	Sensor cable (3 m) + Connector (1 pc.)

Note) At the factory, the connector is not connected to the cable, but packed together with it for shipment.

Specifications

Model	PSE530-M5	PSE531-M5	PSE532-M5	PSE533-M5
Rated pressure range	0 to 1 MPa	0 to -101 kPa	0 to 101 kPa	-101 to 101 kPa
Proof pressure	1.5 MPa	500kPa		
Fluid	Air/Non-corrosive gas			
Power supply voltage	12 to 24 VDC (Ripple \pm 10% or less)			
Current consumption	15 mA or less			
Output specification	Analog output (1 to 5 V, Output impedance: Approx. 1 k Ω)			
Accuracy	\pm 2% F.S. or less (Within rated pressure range, Ambient temperature 25 $^{\circ}$ \pm 3 $^{\circ}$ C)			
Linearity	\pm 1% F.S. or less			
Repeatability	\pm 1% F.S. or less			
Power supply voltage effect	\pm 1% F.S. or less based on the analog output at 18 V ranging from 12 to 24 VDC			
Resistance	Enclosure	IP40		
	Temperature range	0 $^{\circ}$ to 50 $^{\circ}$ C; Stored: -10 $^{\circ}$ to 70 $^{\circ}$ C (No freezing or condensation)		
	Withstand voltage	1000 VAC, 50/60Hz for 1 minute between external terminals and case		
	Insulation resistance	5 M Ω between external terminals and case (at 50 VDC)		
	Vibration resistance	10 to 500 Hz at whichever is smaller of 1.5 mm amplitude or 98 m/s 2 acceleration, in X, Y, Z directions, for 2 hours each (De-energized)		
	Impact resistance	980 m/s 2 in X, Y, Z directions, 3 times each (De-energized)		
Temperature characteristics (Based on 25 $^{\circ}$ C)	\pm 2% F.S. or less based on the analog output value at 25 $^{\circ}$ C from a range of 0 $^{\circ}$ to 50 $^{\circ}$ C			
Port size	M5 x 0.8			
Material	Body: Stainless steel Grade 303, Internal enclosure: PPE; Pressure sensor: Silicon; O-ring: NBR			
Sensor cable/Option	Halogen-free heavy-duty cord, ϕ 2.7, 0.15 mm 2 , 3 cores, 3 m			

Internal Circuit

	Sensor cable color
DC (+) Power supply	Brown
DC (-) GND	Blue
Analog output (1 to 5 V)	Black

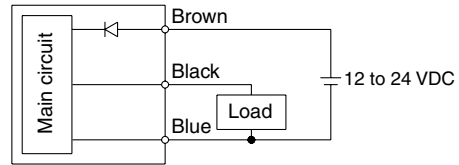

Dimensions

PSE53□-M5

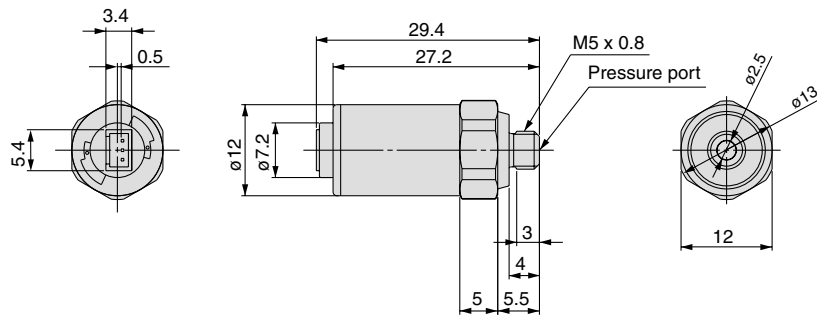

With sensor cable

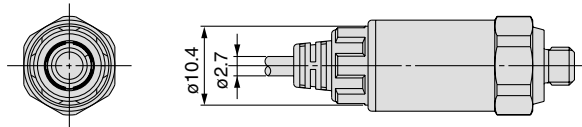

ZSE□
ISE□

PSE

ZSE3

PS

ZSE1
2

ZSP

ISA2

IS□

ZSM

PF2□

IF□

Data



Series PSE

Specific Product Precautions 1

Be sure to read before handling.

Pressure Sensor

Handling

Warning

1. Do not drop, bump, or apply excessive impacts (980 m/s²) while handling. Although the body of the sensor may not be damaged, the inside of the sensor could be damaged and lead to a malfunction.
2. The tensile strength of the cord is 23 N. Applying a greater pulling force on it can cause a malfunction. When handling, hold the body of the sensor—do not dangle it from the cord.
3. Do not exceed the screw-in torque of 3.5 N·m when installing piping. Exceeding this value may cause malfunctioning of the sensor.
4. Do not use pressure sensors with corrosive and/or inflammable gases or liquids.
5. Connecting the sensor cable (Option)

Hold the female connector of the sensor cable with your fingers and carefully insert it into the connector.

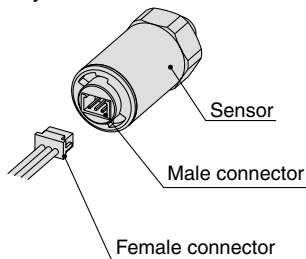

A connector cover is provided as part of the cable assembly (see the figure below). It is designed to keep the female connector from slipping out of the sensor. To lock the connector cover in place, first make sure it is facing in the right direction as you slip it over the female connector, then lock it to the sensor body by turning it clockwise. To remove the cover, first unlock it by turning it counterclockwise, then pull back on it. To remove the female connector, grab it with your fingers and pull back on it. Do not pull on the cable.

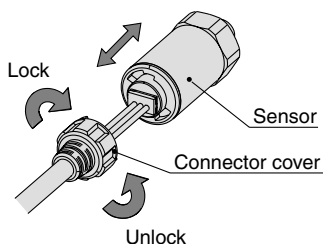

Operating Environment

Warning

1. The pressure sensors are CE marked; however, they are not equipped with surge protection against lightning. Lightning surge countermeasures should be applied directly to system components as necessary.
2. The pressure sensors do not have an explosion proof rating. Never use pressure sensors in the presence of inflammable or explosive gases.

Controller

Handling

Warning

1. Do not drop, bump, or apply excessive impacts (1000 m/s²) while handling. Although the body of the controller case may not be damaged, the inside of the controller could be damaged and cause a malfunction.
2. The tensile strength of the power supply/output connection cable is 50 N; that of the pressure sensor lead wire with connector is 25 N. Applying a greater pulling force than the applicable specified tensile strength to either of these components can lead to a malfunction. When handling, hold the body of the controller—do not dangle it from the cord.

Connection

Warning

1. Incorrect wiring can damage the switch and cause a malfunction or erroneous switch output. Connections should be done while the power is turned off.
2. Do not attempt to insert or pull the pressure sensor or its connector when the power is on. Switch output may malfunction.
3. Wire separately from power lines and high voltage lines, avoiding wiring in the same conduit with these lines. Malfunctions may occur due to noise from these other lines.
4. If a commercial switching regulator is used, make sure that the F.G. terminal is grounded.

Operating Environment

Warning

1. Our multi-channel pressure sensor controllers are CE marked; however, they are not equipped with surge protection against lightning. Lightning surge countermeasures should be applied directly to system components as necessary.
2. Our multi-channel pressure sensor controllers do not have an explosion proof rating. Never use pressure sensors in the presence of inflammable or explosive gases.
3. Enclosure "IP65" applies only to the front face of the panel when mounting. Do not use in an environment where oil splashing or spraying are anticipated.

ZSE□
ISE□

PSE

ZSE3
I SE3

PS

ZSE1
I SE2

ZSP

ISA2

IS□

ZSM

PF2□

IF□

Data



Specific Product Precautions 2

Be sure to read before handling.

Mounting

⚠ Caution

The front face of the panel mount conforms to IP65 (IP40 when using the □48 conversion adapter); however, there is a possibility of liquid filtration if the panel mount adapter is not installed securely and properly. Securely fix the adaptor with screws as shown below.

Standard

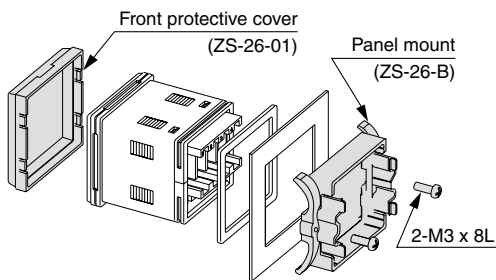

Tighten screws 1/4 to 1/2 turn after the heads are flush with the panel.

When using □48 conversion adapter

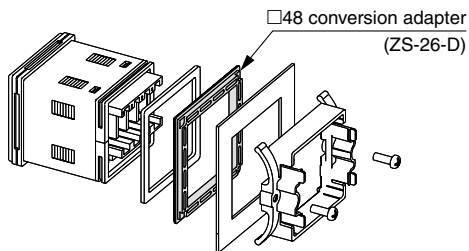

Wiring

⚠ Caution

1. Connecting sensor cable and connector (ZS-26-E)

- Cut the sensor cable as shown below.
- Insert each lead wire into the corresponding connector number by following the chart provided below.

Connector no.	Core wire color of sensor cable
1	Brown (DC+)
2	Black (Analog output)
3	Blue (DC-)
4	N.C.

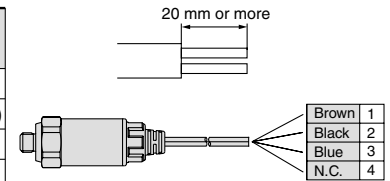

- Make sure that the number of connector and the core wire color match. After verifying that the wires are inserted all the way, temporarily hold the connector down manually.
- Using pliers, snap A into B as shown below so that there is no gap between A and B, and secure the connector.
- The A and B portion of the sensor connector are already tacked down temporarily at the time of shipment. Do not snap the A portion in place before inserting the cable. Note that the connector cannot be taken apart to be reused once it is crimped. Use a new sensor connector in case wiring or the snapping of A into B are done incorrectly.

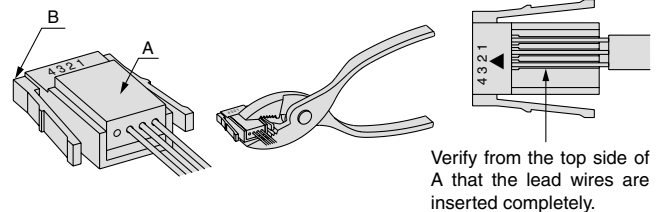

- To connect the connector to the multi-channel pressure sensor, push the connector with its A portion facing toward you into the socket until it clicks as shown below.
- To remove the connector, pull it straight out while applying pressure to the fingers on both sides.

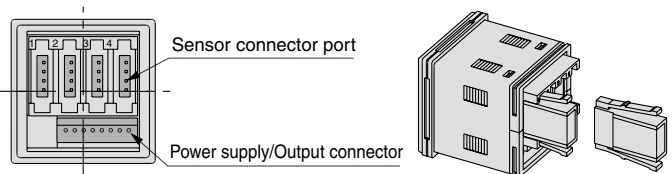

2. Connecting power supply/output connection cable

- To connect the power supply/output connection cable to the controller, insert the cable connector with the C part facing down until it clicks.

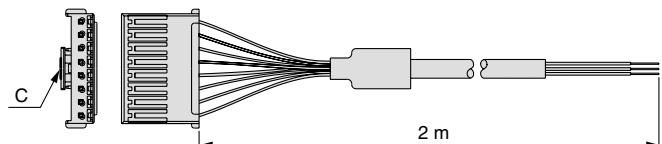



Wiring

⚠ Caution

3. Connecting to other series

- Any pressure sensor (SW) can be connected as long as it generates analog output (1 to 5 V) signal. However, the pressure range must match.
- SMC pressure sensors, Series PSE510 & PSE520, are also connectable.
- When connecting to pressure sensors other than the Series PSE530, connector types will vary depending on the wire core size of the cable and the outside diameter of the insulation cover. Refer to the table provided below.

Connector part no.	Wire core size	Insulation cover O.D.	Sensor part no.
ZS-26-E	AWG24-26 (0.14 to 0.2 mm ²)	ø1.0 to 1.4	PSE510, PSE530
ZS-26-E-1	AWG24-26 (0.14 to 0.2 mm ²)	ø1.4 to 2.0	
ZS-26-E-2	AWG20-22 (0.3 to 0.5 mm ²)	ø1.0 to 1.4	PSE521
ZS-26-E-3	AWG20-22 (0.3 to 0.5 mm ²)	ø1.4 to 2.0	PSE520

- Refer to the following diagram for connecting Series PSE520 to the connector.

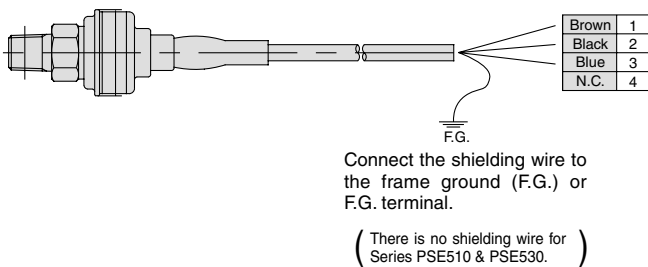

Regulating Pressure Range & Rated Pressure Range

⚠ Caution

1. Regulating pressure range: Refers to allowable pressure range in a pressure setting mode.

- Setting range is between P_1(n_1) to P_4(n_4).
- For Series PSE200, the regulating pressure range and the setting pressure range that can be displayed are the same.

2. Rated pressure range: Refers to the pressure range that satisfies the product specifications.

- Pressure range that satisfies the product specifications (accuracy and linearity) for PSE530.

ZSE□
ISE□

PSE

ZSE3

PS

ZSE1

ZSP

ISA2

IS□

ZSM

PF2□

IF□

Data



Safety Instructions

These safety instructions are intended to prevent a hazardous situation and/or equipment damage. These instructions indicate the level of potential hazard by labels of "Caution", "Warning" or "Danger". To ensure safety, be sure to observe ISO 4414 ^{Note 1)}, JIS B 8370 ^{Note 2)} and other safety practices.

 **Caution** : Operator error could result in injury or equipment damage.

 **Warning** : Operator error could result in serious injury or loss of life.

 **Danger** : In extreme conditions, there is a possible result of serious injury or loss of life.

Note 1) ISO 4414: Pneumatic fluid power--General rules relating to systems.

Note 2) JIS B 8370: General Rules for Pneumatic Equipment

Warning

1. The compatibility of pneumatic equipment is the responsibility of the person who designs the pneumatic system or decides its specifications.

Since the products specified here are used in various operating conditions, their compatibility for the specific pneumatic system must be based on specifications or after analysis and/or tests to meet your specific requirements. The expected performance and safety assurance will be the responsibility of the person who has determined the compatibility of the system. This person should continuously review the suitability of all items specified, referring to the latest catalog information with a view to giving due consideration to any possibility of equipment failure when configuring a system.

2. Only trained personnel should operate pneumatically operated machinery and equipment.

Compressed air can be dangerous if an operator is unfamiliar with it. Assembly, handling or repair of pneumatic systems should be performed by trained and experienced operators.

3. Do not service machinery/equipment or attempt to remove components until safety is confirmed.

1. Inspection and maintenance of machinery/equipment should only be performed once measures to prevent falling or runaway of the driver objects have been confirmed.
2. When equipment is to be removed, confirm the safety process as mentioned above. Cut the supply pressure for this equipment and exhaust all residual compressed air in the system.
3. Before machinery/equipment is restarted, take measures to prevent shooting-out of cylinder piston rod, etc.

4. Contact SMC if the product is to be used in any of the following conditions:

1. Conditions and environments beyond the given specifications, or if product is used outdoors.
2. Installation on equipment in conjunction with atomic energy, railway, air navigation, vehicles, medical equipment, food and beverages, recreation equipment, emergency stop circuits, clutch and brake circuits in press applications, or safety equipment.
3. An application which has the possibility of having negative effects on people, property, or animals, requiring special safety analysis.



Common Precautions

Be sure to read before handling.

For detailed precautions on every series, refer to main text.

Selection

Warning

1. Confirm the specifications.

Products represented in this catalog are designed for use in compressed air applications only (including vacuum), unless otherwise indicated.

Do not use the product outside their design parameters.

Please contact SMC when using the products in applications other than compressed air (including vacuum).

Mounting

Warning

1. Instruction manual

Install the products and operate them only after reading the instruction manual carefully and understanding its contents. Also keep the manual where it can be referred to as necessary.

2. Securing the space for maintenance

When installing the products, please allow access for maintenance.

3. Tightening torque

When installing the products, please follow the listed torque specifications.

Piping

Caution

1. Before piping

Make sure that all debris, cutting oil, dust, etc., are removed from the piping.

2. Wrapping of pipe tape

When screwing piping or fittings into ports, ensure that chips from the pipe threads or sealing material do not get inside the piping. Also, when the pipe tape is used, leave 1.5 to 2 thread ridges exposed at the end of the threads.

Air Supply

Warning

1. Operating fluid

Please consult with SMC when using the product in applications other than compressed air (including vacuum).

Regarding products for general fluid, please ask SMC about applicable fluids.

2. Install an air dryer, aftercooler, etc.

Excessive condensate in a compressed air system may cause valves and other pneumatic equipment to malfunction.

Installation of an air dryer, after cooler etc. is recommended.

3. Drain flushing

If condensate in the drain bowl is not emptied on a regular basis, the bowl will over flow and allow the condensate to enter the compressed air lines.

If the drain bowl is difficult to check and remove, it is recommended that a drain bowl with the auto-drain option be installed.

For compressed air quality, refer to "Air Preparation Equipment" catalog.

4. Use clean air

If the compressed air supply is contaminated with chemicals, synthetic materials, corrosive gas, etc., it may lead to break down or malfunction.

Operating Environment

Warning

1. Do not use in environments where the product is directly exposed to corrosive gases, chemicals, salt water, water or steam.

2. Do not expose the product to direct sunlight for an extended period of time.

3. Do not use in a place subject to heavy vibrations and/or shocks.

4. Do not mount the product in locations where it is exposed to radiant heat.

Maintenance

Warning

1. Maintenance procedures are outlined in the operation manual.

Not following proper procedures could cause the product to malfunction and could lead to damage to the equipment or machine.

2. Maintenance work

If handled improperly, compressed air can be dangerous.

Assembly, handling and repair of pneumatic systems should be performed by qualified personnel only.

3. Drain flushing

Remove drainage from air filters regularly. (Refer to the specifications.)

4. Shut-down before maintenance

Before attempting any kind of maintenance make sure the supply pressure is shut of and all residual air pressure is released from the system to be worked on.

5. Start-up after maintenance and inspection

Apply operating pressure and power to the equipment and check for proper operation and possible air leaks. If operation is abnormal, please verify product set-up parameters.

6. Do not make any modifications to be product.

Do not take the product apart.

Quality Assurance Information (ISO 9001, ISO 14001)

Reliable quality of products in the global market

To enable our customers throughout the world to use our products with even greater confidence, SMC has obtained certification for international standards “ISO 9001” and “ISO 14001”, and created a complete structure for quality assurance and environmental controls. SMC products pursue to meet its customers’ expectations while also considering company’s contribution in society.

Quality management system ISO 9001

This is an international standard for quality control and quality assurance. SMC has obtained a large number of certifications in Japan and overseas, providing assurance to our customers throughout the world.



Environmental management system ISO 14001

This is an international standard related to environmental management systems and environmental inspections. While promoting environmentally friendly automation technology, SMC is also making diligent efforts to preserve the environment.



SMC’s quality control system

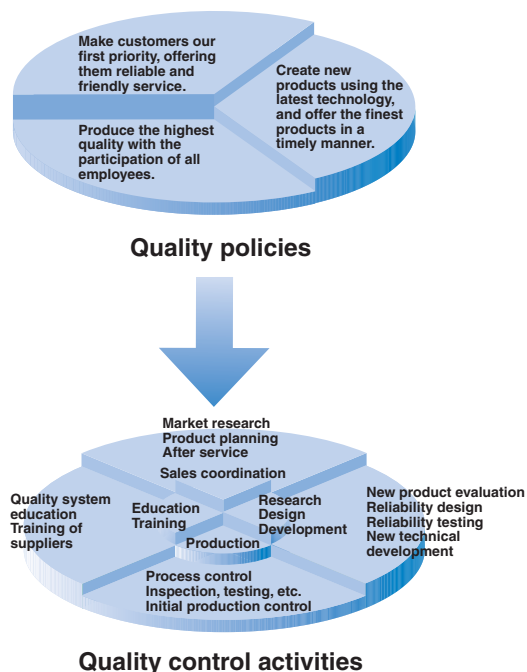

SMC Product Conforming to Inter

SMC products complying with EN/ISO, CSA/UL standards are supporting



The CE mark indicates that machines and components meet essential requirements of all the EC Directives applied.

It has been obligatory to apply CE marks indicating conformity with EC Directives when machines and components are exported to the member Nations of the EU.

Once "A manufacturer himself" declares a product to be safe by means of CE marking (declaration of conformity by manufacturer), free distribution inside the member Nations of the EU is permissible.

■ CE Mark

SMC provides CE marking to products to which EMC and Low Voltage Directives have been applied, in accordance with CETOP (European hydraulics and pneumatics committee) guide lines.

■ As of February 1998, the following 18 countries will be obliged to conform to CE mark legislation

Iceland, Ireland, United Kingdom, Italy, Austria, Netherlands, Greece, Liechtenstein, Sweden, Spain, Denmark, Germany, Norway, Finland, France, Belgium, Portugal, Luxembourg

■ EC Directives and Pneumatic Components

• Machinery Directive

The Machinery Directive contains essential health and safety requirements for machinery, as applied to industrial machines e.g. machine tools, injection molding machines and automatic machines. Pneumatic equipment is not specified in Machinery Directive. However, the use of SMC products that are certified as conforming to EN Standards, allows customers to simplify preparation work of the Technical Construction File required for a Declaration of Conformity.

• Electromagnetic Compatibility (EMC) Directive

The EMC Directive specifies electromagnetic compatibility. Equipment which may generate electromagnetic interference or whose function may be compromised by electromagnetic interference is required to be immune to electromagnetic affects (EMS/immunity) without emitting excessive electromagnetic affects (EMI/emission).

• Low Voltage Directive

This directive is applied to products, which operate above 50 VAC to 1000 VAC and 75 VDC to 1500 VDC operating voltage, and require electrical safety measures to be introduced.

• Simple Pressure Vessels Directive

This directive is applied to welded vessels whose maximum operating pressure (PS) and volume of vessel (V) exceed 50 bar/L. Such vessels require EC type examination and then CE marking.

national Standards

you to comply with EC directives and CSA/UL standards.



■ CSA Standards & UL Standards

UL and CSA standards have been applied in North America (U.S.A. and Canada) symbolizing safety of electric products, and are defined to mainly prevent danger from electric shock or fire, resulting from trouble with electric products. Both UL and CSA standards are acknowledged in North America as the first class certifying body. They have a long experience and ability for issuing product safety certificate. Products approved by CSA or UL standards are accepted in most states and governments beyond question.

Since CSA is a test certifying body as the National Recognized Testing Laboratory (NRTL) within the jurisdiction of Occupational Safety and Health Administration (OSHA), SMC was tested for compliance with CSA Standards and UL Standards at the same time and was approved for compliance with the two Standards. The above CSA NRTL/C logo is described on a product label in order to indicate that the product is approved by CSA and UL Standards.

■ TSSA (MCCR) Registration Products

TSSA is the regulation in Ontario State, Canada. The products that the operating pressure is more than 5 psi (0.03 MPa) and the piping size is bigger than 1 inch. fall into the scope of TSSA regulation.

Products conforming to CE Standard



With CE symbol for simple visual recognition

In this catalog each accredited product series is indicated with a CE mark symbol. However, in some cases, every available models may not meet CE compliance. Please visit our web site for the latest selection of available models with CE mark.

<http://www.smcworld.com>

SMC's Global Service Network

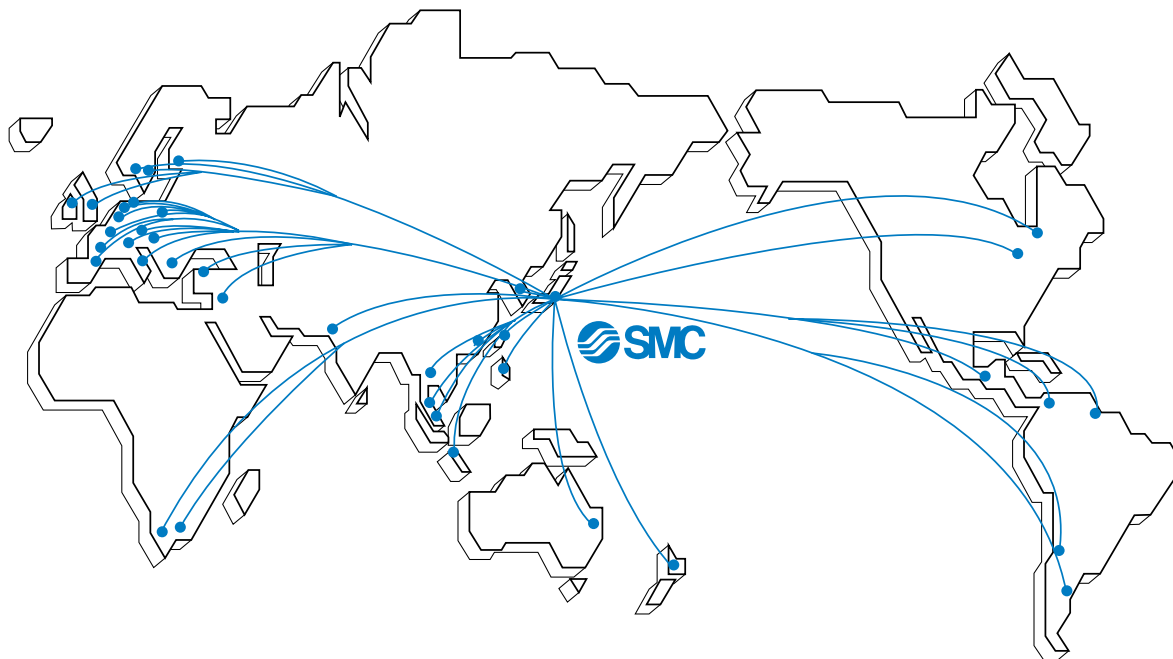

America

U.S.A. **SMC Corporation of America**

3011 North Franklin Road Indianapolis, IN 46226, U.S.A.
TEL: 317-899-4440 FAX: 317-899-3102

CANADA **SMC Pneumatics (Canada) Ltd.**

6768 Financial Drive Mississauga, Ontario, L5N 7J6 Canada
TEL: 905-812-0400 FAX: 905-812-8686

MEXICO **SMC Corporation (Mexico), S.A. DE C.V.**

Carr. Silao-Trejo K.M. 2.5 S/N, Predio San Jose del Duranzo
C.P. 36100, Silao, Gto., Mexico
TEL: 472-72-2-55-00 FAX: 472-72-2-59-44/2-59-46

CHILE **SMC Pneumatics (Chile) S.A.**

Av. La Montaña 1,115 km. 16.5 P. Norte Parque
Industrial Valle Grande, Lampa Santiago, Chile
TEL: 02-270-8600 FAX: 02-270-8601

ARGENTINA **SMC Argentina S.A.**

Teodoro Garcia 3860 (1427) Buenos Aires, Argentina
TEL: 011-4555-5762 FAX: 011-4555-5762

BOLIVIA **SMC Pneumatics Bolivia S.R.L.**

Avenida Beni Numero 4665
Santa Cruz de la Sierra-Casilla de Correo 2281, Bolivia
TEL: 591-3-3428383 FAX: 591-3-3449900

VENEZUELA **SMC Neumatica Venezuela S.A.**

Apartado 40152, Avenida Nueva Granada, Edificio Wanlac,
Local 5, Caracas 1040-A, Venezuela
TEL: 2-632-1310 FAX: 2-632-3871

PERU (Distributor) **IMPECO Automatizacion Industrial S.A.**

AV. Canevaro 752, Lince, Lima, Peru
TEL: 1-471-6002 FAX: 1-471-0935

URUGUAY (Distributor) **BAKO S.A.**

Galicia 1650 esq. Gaboto C.P. 11200, Montevideo, Uruguay
TEL: 2-401-6603 FAX: 2-409-4306

BRAZIL **SMC Pneumaticos Do Brasil Ltda.**

Rua. Dra. Maria Fidelis, nr. 130, Jardim Piraporinha-Diadema-S.P.
CEP: 09950-350, Brasil
TEL: 11-4051-1177 FAX: 11-4071-6636

COLOMBIA (Distributor) **Airmatic Ltda.**

Calle 18 69-05 Apart. Aereo 081045 Santa Fe de Bogotá, Colombia
TEL: 1-424-9240 FAX: 1-424-9260

Europe

U.K. **SMC Pneumatics (U.K.) Ltd.**

Vincent Avenue, Crownhill, Milton Keynes, MK8 0AN, Buckinghamshire, U.K.
TEL: 01908-563888 FAX: 01908-561185

GERMANY **SMC Pneumatik GmbH**

Boschring 13-15 D-63329 Egelsbach, Germany
TEL: 06103-4020 FAX: 06103-402139

ITALY **SMC Italia S.p.A.**

Via Garibaldi 62 I-20061 Carugate Milano, Italy
TEL: 02-9271365 FAX: 02-9271365

FRANCE **SMC Pneumatique S.A.**

1 Boulevard de Strasbourg, Parc Gustave Eiffel, Bussy Saint Georges, F-77600
Marne La Vallee Cedex 3 France
TEL: 01-64-76-10-00 FAX: 01-64-76-10-10

SWEDEN **SMC Pneumatics Sweden AB**

Ekhagsvägen 29-31, S-141 05 Huddinge, Sweden
TEL: 08-603-07-00 FAX: 08-603-07-10

SWITZERLAND **SMC Pneumatik AG**

Dorfstrasse 7, Postfach 117, CH-8484 Weisslingen, Switzerland
TEL: 052-396-3131 FAX: 052-396-3191

AUSTRIA **SMC Pneumatik GmbH (Austria)**

Girakstrasse 8, A-2100 Korneuburg, Austria
TEL: 0-2262-6228-0 FAX: 0-2262-62285

SPAIN **SMC España, S.A.**

Zuazobidea 14 Pol. Ind. Júndiz 01015 Vitoria, Spain
TEL: 945-184-100 FAX: 945-184-510

IRELAND **SMC Pneumatics (Ireland) Ltd.**

2002 Citywest Business Campus, Naas Road, Saggart, Co. Dublin, Ireland
TEL: 01-403-9000 FAX: 01-466-0385

NETHERLANDS (Associated company) **SMC Pneumatics BV**

De Ruyterkade 120, NL-1011 AB Amsterdam, Netherlands
TEL: 020-5318888 FAX: 020-5318880

GREECE (Distributor) **S.Parianopoulos S.A.**

7, Konstantinoupoleos Street 11855 Athens, Greece
TEL: 01-3426076 FAX: 01-3455578

DENMARK **SMC Pneumatik A/S**

Knudsminde 4 B DK-8300
Odder, Denmark
TEL: 70252900 FAX: 70252901

Europe

FINLAND SMC Pneumatics Finland OY

PL72, Tiistiniityntie 4, SF-02231 ESP00, Finland
TEL: 09-8595-80 FAX: 09-8595-8595

NORWAY SMC Pneumatics Norway A/S

Vollsvæien 13C, Granfoss Næringspark N-1366 LYSAKER, Norway
TEL: 67-12-90-20 FAX: 67-12-90-21

BELGIUM (Distributor) SMC Pneumatics N.V./S.A.

Nijverheidsstraat 20 B-2160 Wommelgem Belgium
TEL: 03-355-1464 FAX: 03-355-1466

POLAND SMC Industrial Automation Polska Sp.z.o.o.

ul. Konstruktorska 11A, PL-02-673 Warszawa, Poland
TEL: 022-548-5085 FAX: 022-548-5087

TURKEY (Distributor) Entek Pnömatik San.ve Tic. Ltd. Sti

Perpa Tic. Merkezi Kat:11 No.1625 80270 Okmeydani Istanbul, Türkiye
TEL: 0212-221-1512 FAX: 0212-221-1519

RUSSIA SMC Pneumatik LLC.

36/40 Sredny prospect V.O. St. Petersburg 199004, Russia
TEL: 812-118-5445 FAX: 812-118-5449

CZECH SMC Industrial Automation CZ s.r.o.

Hudcova 78a, CZ-61200 Brno, Czech Republic
TEL: 05-4121-8034 FAX: 05-4121-8034

HUNGARY SMC Hungary Ipari Automatizálási kft.

Budafoki ut 107-113 1117 Budapest
TEL: 01-371-1343 FAX: 01-371-1344

ROMANIA SMC Romania S.r.l.

Str. Frunzei, Nr. 29, Sector 2, Bucharest, Romania
TEL: 01-3205111 FAX: 01-3261489

SLOVAKIA SMC Priemyselná automatizácia, s.r.o.

Nova 3, SK-83103 Bratislava
TEL: 02-4445-6725 FAX: 02-4445-6028

SLOVENIA SMC Industrijska Avtomatila d.o.o.

Grajski trg 15, SLO- 8360 Zuzemberk, Slovenia
TEL: 07388-5240 FAX: 07388-5249

LATVIA SMC Pneumatics Latvia SIA

Šmerļa ielā 1-705, Rīga LV-1006
TEL: 777 94 74 FAX: 777 94 75

SOUTH AFRICA (Distributor) Hyflo Southern Africa (Pty.) Ltd.

P.O.Box 240 Paardeneiland 7420 South Africa
TEL: 021-511-7021 FAX: 021-511-4456

EGYPT (Distributor) Saadani Trading & Ind. Services

15 Sebaai Street, Miami 21411 Alexandria, Egypt
TEL: 3-548-50-34 FAX: 3-548-50-34

Oceania/Asia

AUSTRALIA SMC Pneumatics (Australia) Pty.Ltd.

14-18 Hudson Avenue Castle Hill NSW 2154, Australia
TEL: 02-9354-8222 FAX: 02-9894-5719

NEW ZEALAND SMC Pneumatics (New Zealand) Ltd.

8C Sylvia Park Road Mt.Wellington Auckland, New Zealand
TEL: 09-573-7007 FAX: 09-573-7002

TAIWAN SMC Pneumatics (Taiwan) Co.,Ltd.

17, Lane 205, Nansan Rd., Sec.2, Luzhu-Hsiang, Taoyuan-Hsien, TAIWAN
TEL: 03-322-3443 FAX: 03-322-3387

HONG KONG SMC Pneumatics (Hong Kong) Ltd.

29/F, Clifford Centre, 778-784 Cheung, Sha Wan Road, Lai Chi Kok, Kowloon, Hong Kong
TEL: 2744-0121 FAX: 2785-1314

SINGAPORE SMC Pneumatics (S.E.A.) Pte. Ltd.

89 Tuas Avenue 1, Jurong Singapore 639520
TEL: 6861-0888 FAX: 6861-1889

PHILIPPINES SHOKETSU SMC Corporation

Unit 201 Common Goal Tower, Madrigal Business Park, Ayala Alabang Muntinlupa, Philippines
TEL: 02-8090565 FAX: 02-8090586

MALAYSIA SMC Pneumatics (S.E.A.) Sdn. Bhd.

Lot 36 Jalan Delima1/1, Subang Hi-Tech Industrial Park, Batu 3 40000 Shah Alam Selangor, Malaysia
TEL: 03-56350590 FAX: 03-56350602

SOUTH KOREA SMC Pneumatics Korea Co., Ltd.

Woolim e-BIZ Center (Room 1008), 170-5, Guro-Dong, Guro-Gu, Seoul, 152-050, South Korea
TEL: 02-3219-0700 FAX: 02-3219-0702

CHINA SMC (China) Co., Ltd.

7 Wan Yuan St. Beijing Economic & Technological Development Zone 100176, China
TEL: 010-67882111 FAX: 010-67881837

THAILAND SMC Thailand Ltd.

134/6 Moo 5, Tiwanon Road, Bangkadi, Amphur Muang, Patumthani 12000, Thailand
TEL: 02-963-7099 FAX: 02-501-2937

INDIA SMC Pneumatics (India) Pvt. Ltd.

D-107 to 112, Phase-2, Extension, Noida, Dist. Gautaim Budh Nagar, U.P. 201 305, India
TEL: (0120)-4568730 FAX: 0120-4568933

INDONESIA (Distributor) P.T. Riyadi Putera Makmur

Jalan Hayam Wuruk Komplek Glodok Jaya No. 27-28 Jakarta 11180 Indonesia
TEL: 021-625 5548 FAX: 021-625 5888

PAKISTAN (Distributor) Jubilee Corporation

First Floor Mercantile Centre, Newton Road Near Boulton Market P.O. Box 6165 Karachi 74000 Pakistan
TEL: 021-243-9070/8449 FAX: 021-241-4589

ISRAEL (Distributor) Baccara Automation Control

Kvutza Geva 18915 Israel
TEL: 04-653-5960 FAX: 04-653-1445

SAUDI ARABIA (Distributor) Assaggaff Trading Est.

P.O. Box 3385 Al-Amir Majed Street, Jeddah-21471, Saudi Arabia
TEL: 02-6761574 FAX: 02-6708173